



Wixia GSM



IOT Connectivity:
NB-IOT, LTE-M Uplinks
Remote platform
DIN-35 rail mounting

Wixia GSM module brings NB-IOT and LTE-M connectivity to your Wixia controller.
Select the data you want to send to the Applexia Cloud and visualise data remotely on Applexia visualisation solution to supervise your process.

Powered by



For more information
contact us or explore www.applexia.fr

PINOUT

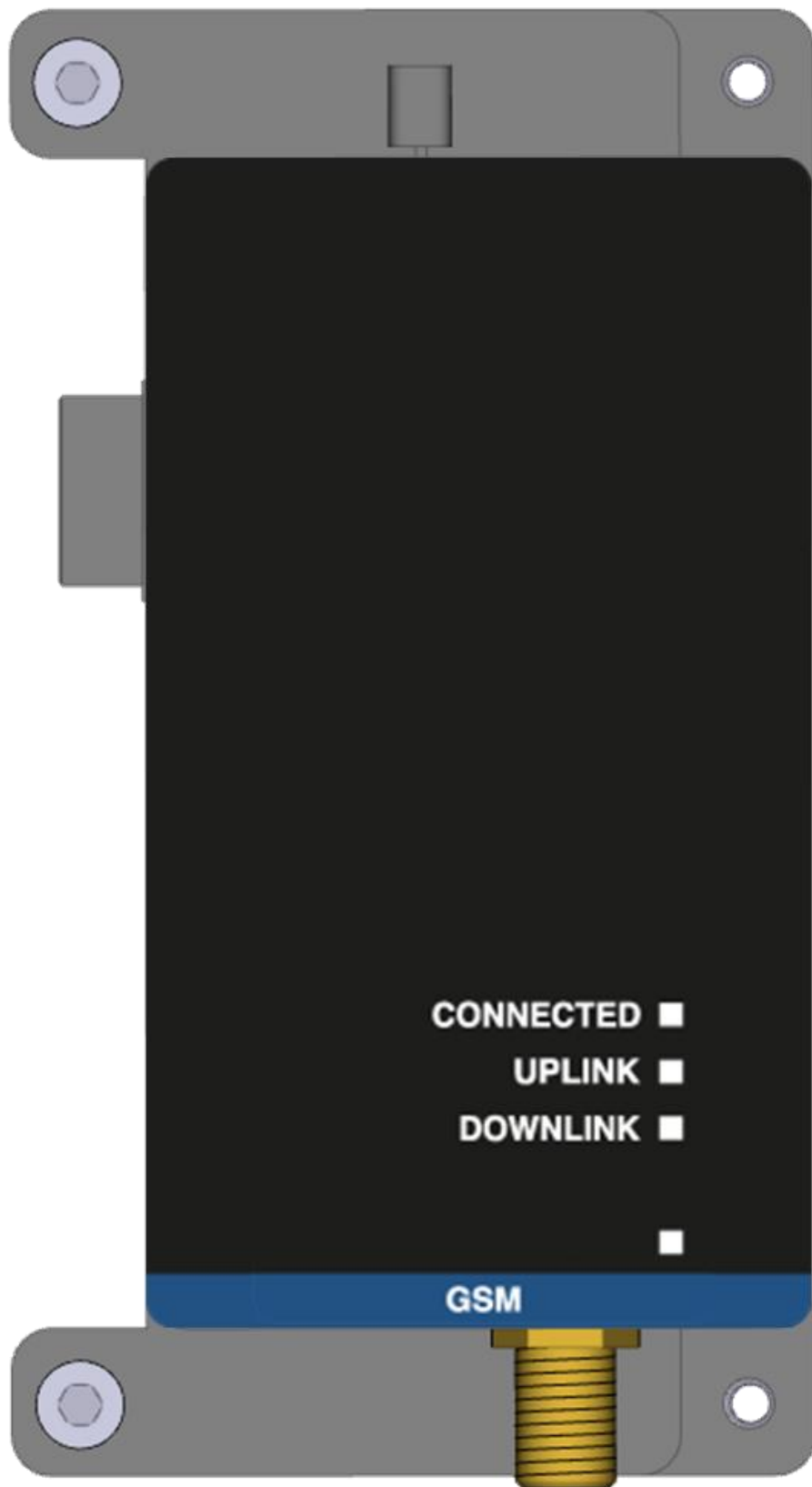

LTE antenna
SMA CONNECTOR



TECHNICAL DATA

GENERAL

Compatibility	To connect to a Wixia-Controller
Power	Provided by Wixia-Controller
Type of connection	SMA connector

GSM PARAMETERS

Uplink	Up to 100 sources per uplink
Downlink	On demand
Sample rate	100ms
Antenna	Not supplied
Carrier frequency	LTE bands 1, 2, 3, 4, 5, 8, 12, 13, 18, 19, 20, 25, 26, 28
Working region	EU
Uplink sending rate	Min 60s Max $2^{32} - 1$ s

OPERATING CONDITIONS

Temperature	-25 to 50°C
Humidity	10 to 80%, non-condensing

MECHANICAL CHARACTERISTICS

Dimensions (lxLxp)	5.0 x 5.1 x 9.1cm
Mounting type	DIN-35 rail
Weight	120g

Powered by



UTILITY

POWER-UP

When powering on the Wixia controller, the GSM module boots up and immediately tries to connect to the Applexia cloud. The state of the CONNECTED LED should display to the user the state of the connection.

CLOUD CONNECTION

Once on, the module connects itself to the Applexia cloud. It happens in two steps:

- 1) The module will try to connect to the NB_IOT or LTE-M network, while doing so the UPLINK and DOWNLINK LED are on (figure 1). If the module fails to connect, it will blink all three LEDs with a period (ω) of 200 ms for 8 seconds, then try connecting again.
- 2) The module will connect to Applexia cloud server, while doing so the UPLINK and CONNECTED LED will be on. If the connection fails, the module will blink all three LEDs with a period (ω) of 1 second for 8 seconds. If module fails at this stage, please contact Applexia support to check if your module as been setup properly.

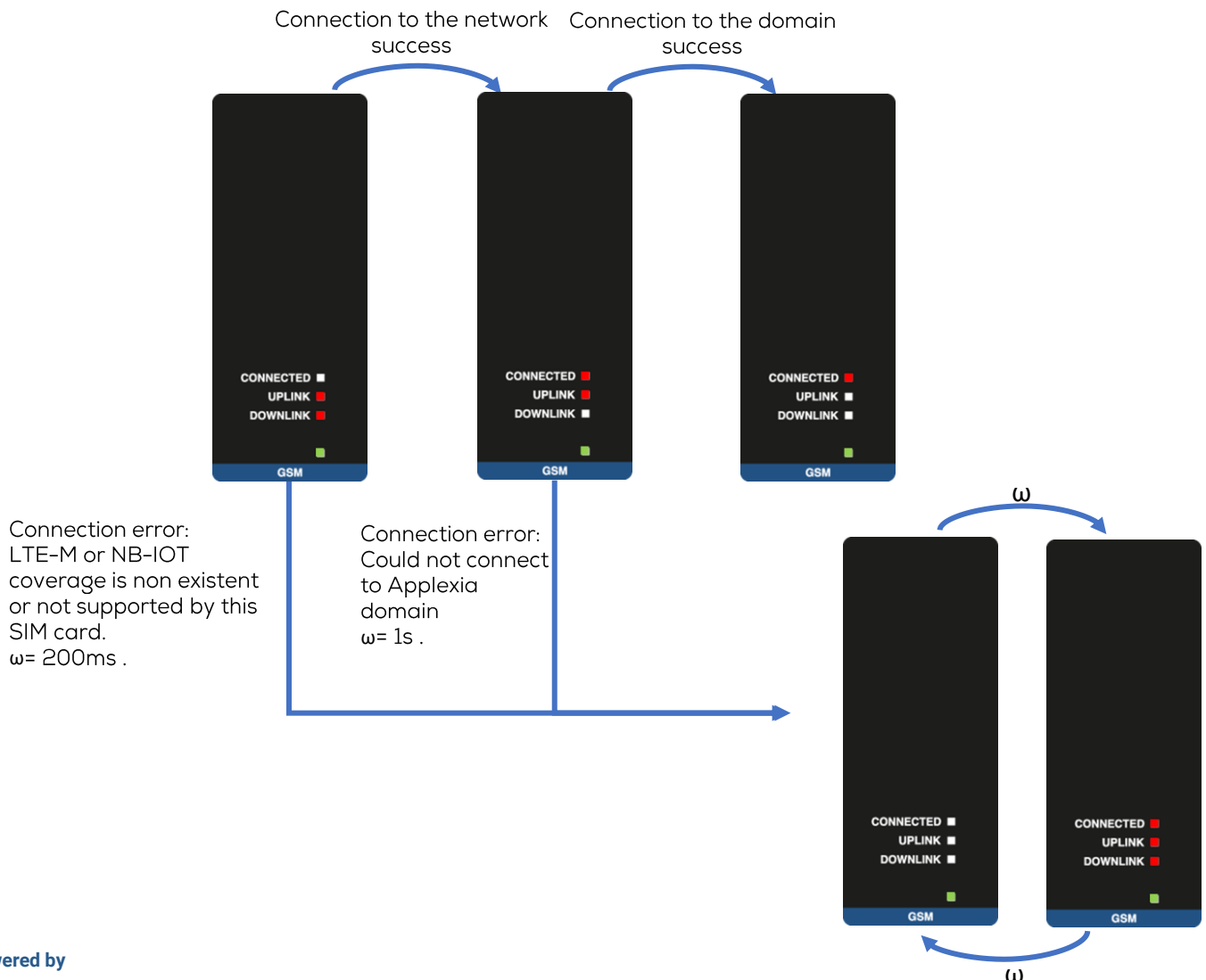

DATA SENDING

The module is designed not to send messages to the domain if certain requirements are not met. In any case the module will try to send data and check at each stage of the send process if the requirements are met.

If the module is well connected to the domain but does not transmit data, there are two cases that can explain this behavior:

- if the DOWNLINK and UPLINK LEDs blink with a period $\omega = 100\text{ms}$, the module doesn't have any sources selected and won't send anything until at least one source is configured.

- if the CONNECTIVITY and DOWNLINK LEDs blink with a period $\omega = 100\text{ms}$, the module is not properly setup, please contact support.

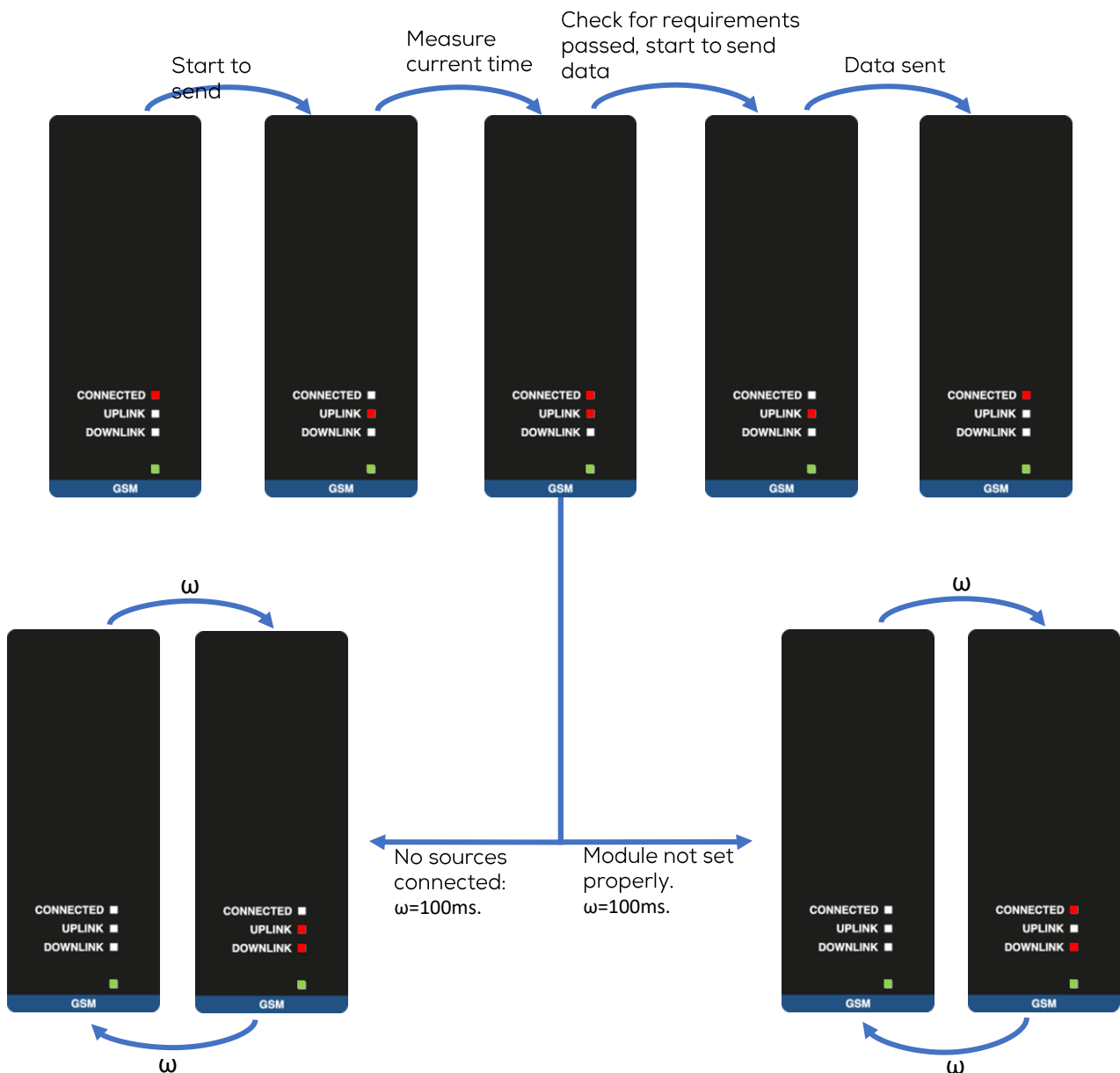

USER SCREEN INTERFACE

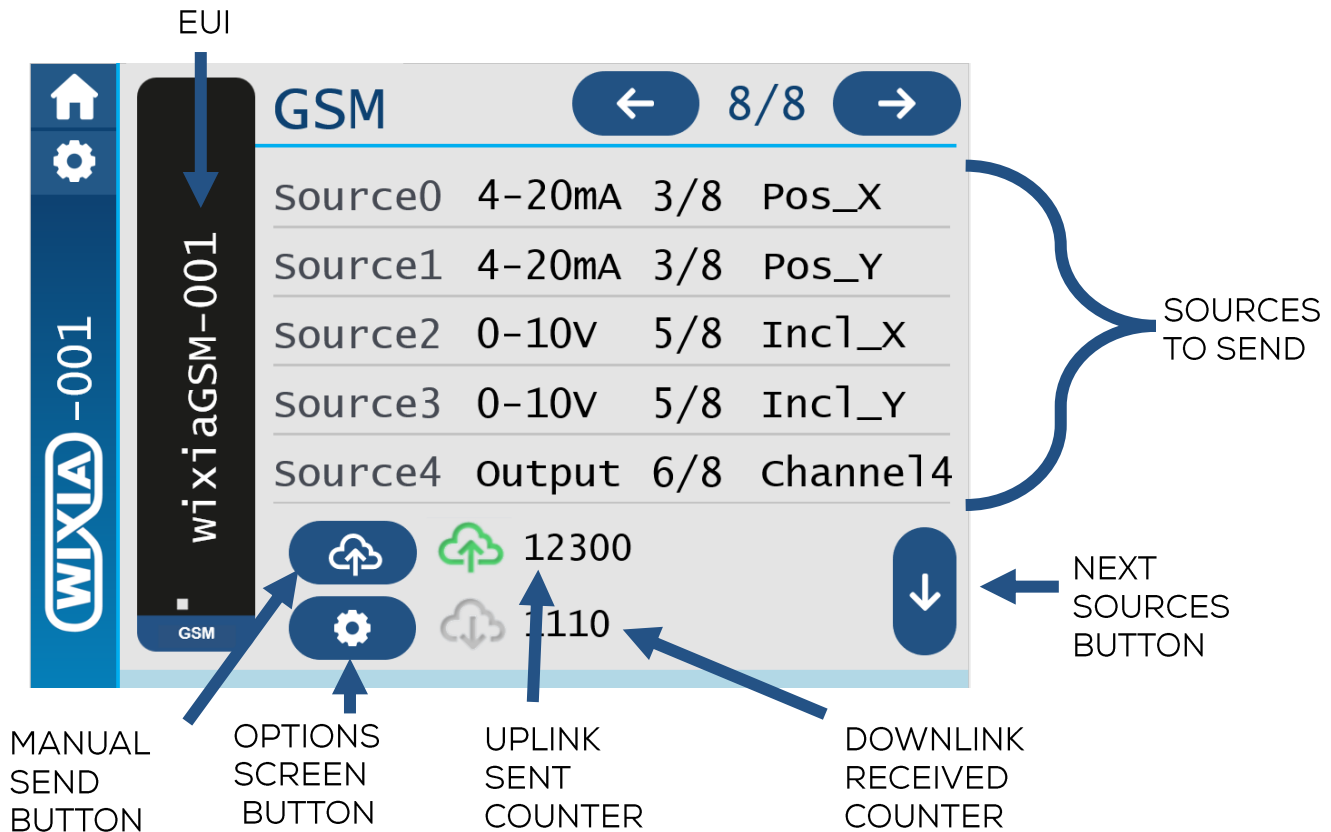

Once the module is turned on and connected to the cloud, the user must specify the data to be sent. The user can manually select the data sources to send to the cloud by clicking on one of the "Source" rows (detailed in the *How to select data sources* section).

- EUI: Unique identifier that allows the processing of messages sent by the module on the cloud.
- SOURCES TO SEND: List of data sources that the user has selected for sending to the cloud via the GSM network.
- MANUAL SEND BUTTON: Performs a manual sending of the selected data.
- OPTIONS SCREEN BUTTON: Displays the options screen interface of the GSM module (see section *Options Screen Interface* for details).
- UPLINK SENT COUNTER: Number of uplinks sent by the module.
- DOWNLINK RECEIVED COUNTER: Number of downlinks received and accepted as valid downlinks. Downlink communication can be implemented on specific demands.
- NEXT SOURCES BUTTON: Displays the list of the next sources.

OPTIONS SCREEN INTERFACE

After pressing the options button, the following configuration menu is displayed. The user can change specific values in the module in order to match the desired application.

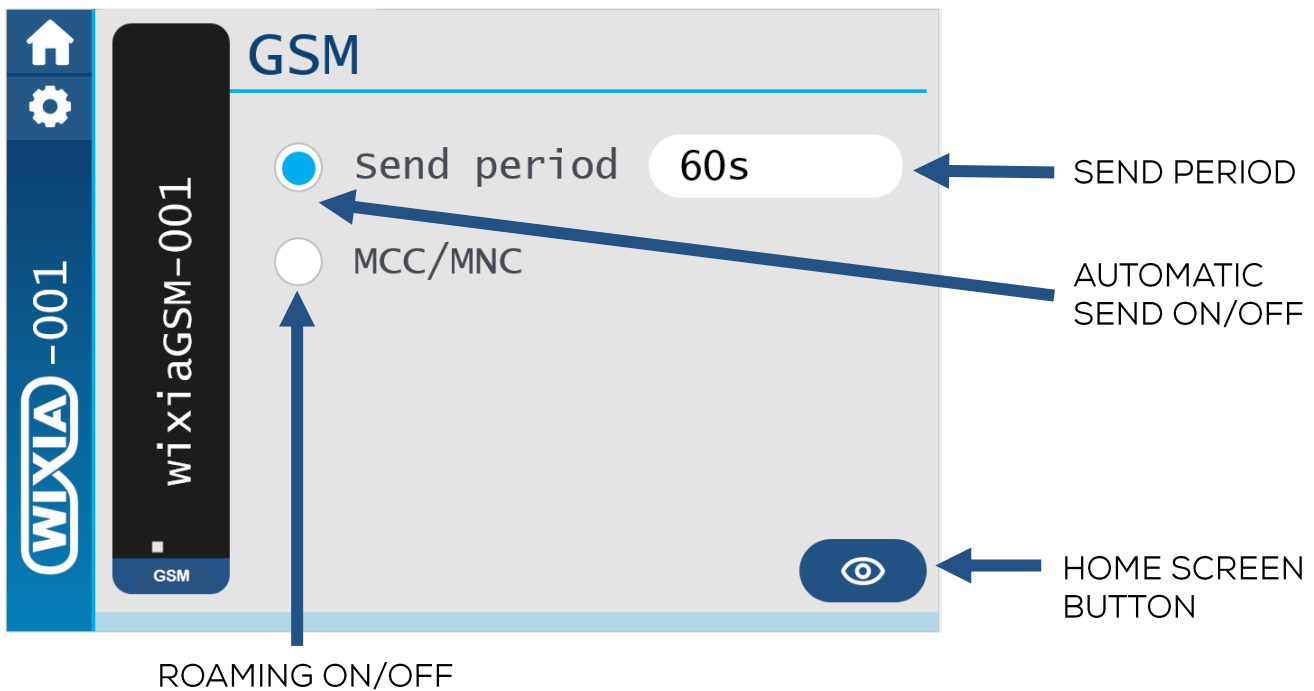

- HOME SCREEN BUTTON: Displays the home screen of the GSM module UI.
- AUTOMATIC SEND ON/OFF: Programs an automatic sending at a defined period. This can be disabled, and the module will no longer send frames automatically.
- SEND PERIOD: Defines the time in seconds between each frame sending in automatic send.
- ROAMING ON/OFF: Allows advanced configuration with a connection to a specific network thanks to roaming. The mobile country code (MCC) is a three-digit country code and the mobile network code (MNC) allows the unique identification of the network of a mobile network operator. For example, the Orange network code in France is MCC=208 and MNC=01; the value for MCC/MNC must be 20801.

HOW TO SELECT DATA SOURCES

1- Click on one of the source rows.



2- Select the module on which the desired data is located.

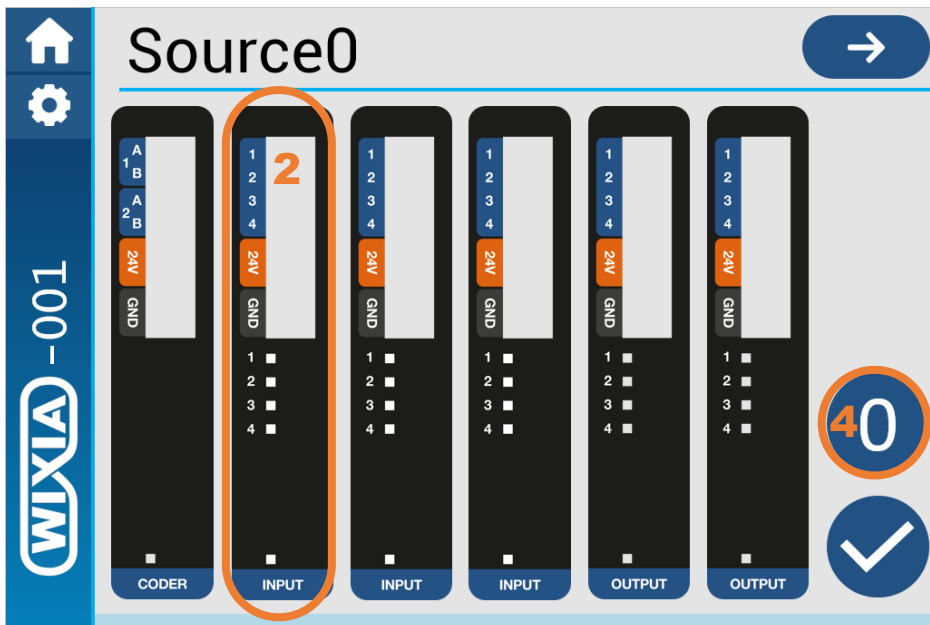

3- Select the desired data by clicking on its selection button.

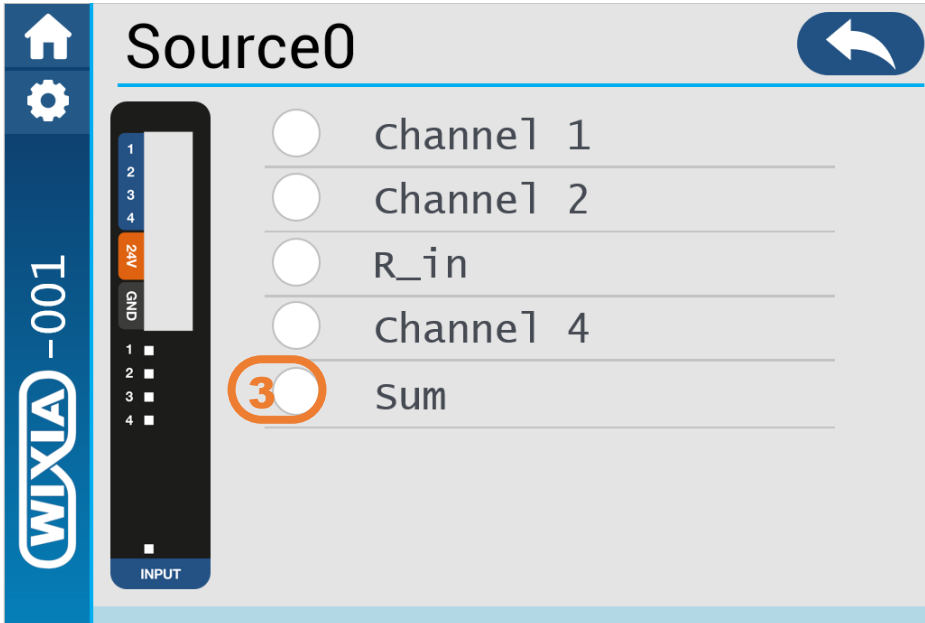

4- The data source selected is now displayed on the GSM module interface.

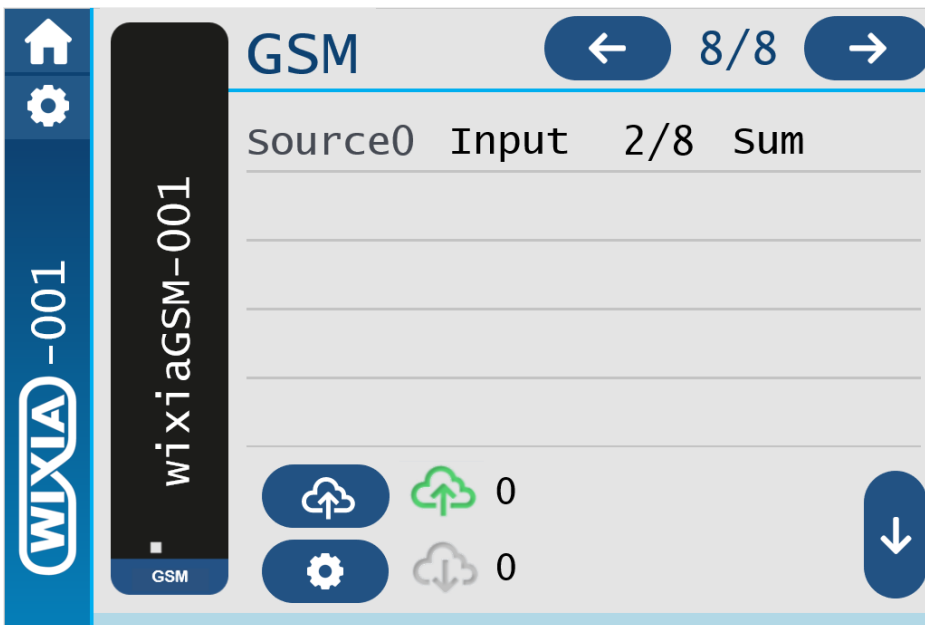

To change the previously configured data source, simply click again on the source line and select another data source.

To completely delete the data source without selecting another, click on the button indicated by (4).

HOW TO SET SENDING PERIOD

1- Click on the automatic send button.

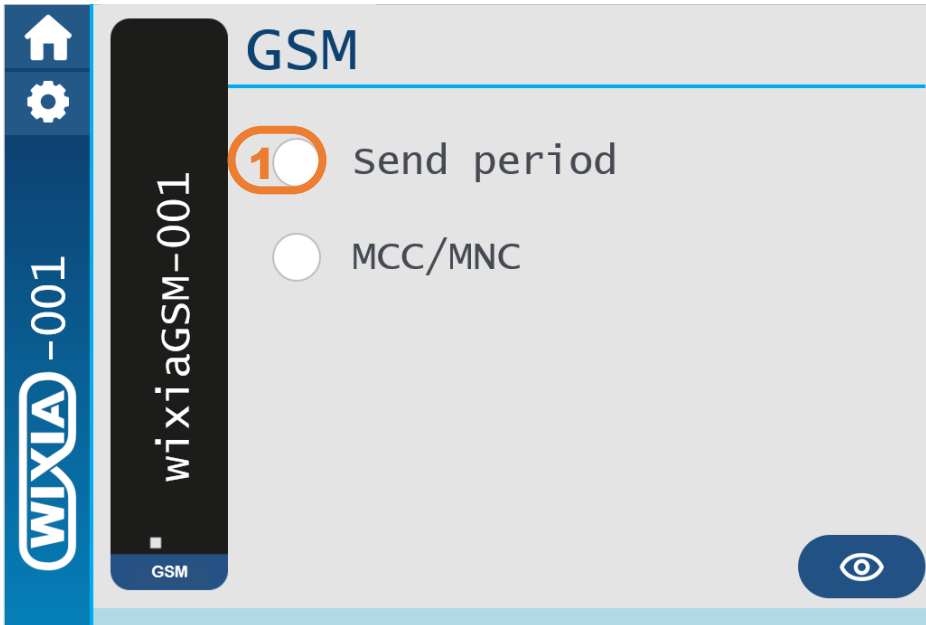

2- Enter the desired value with the keyboard.

3- Click on the validation button

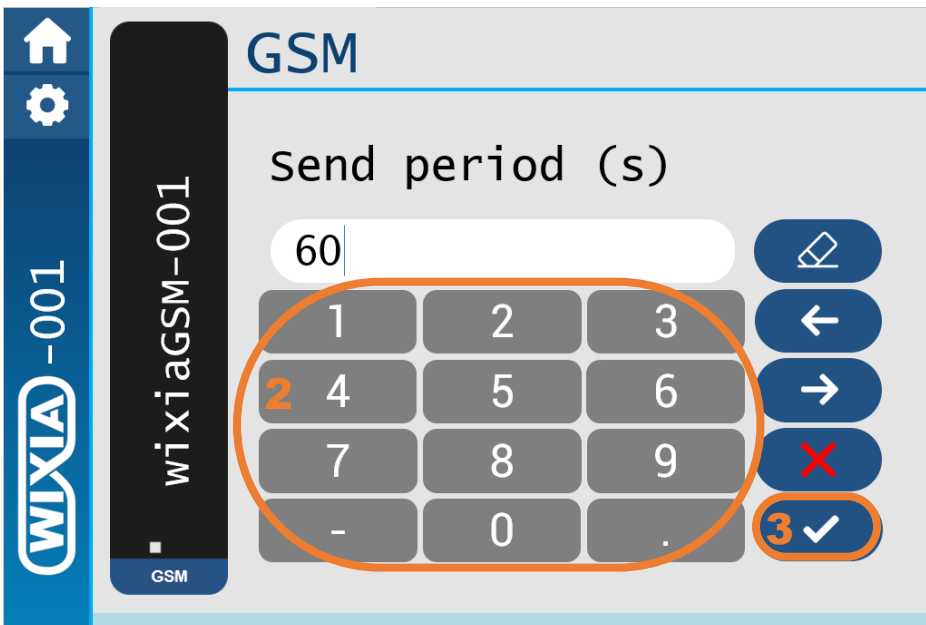

To change the previously configured sending period, simply click on the white input box that indicates the time.

To deactivate automatic sending, click again on the button (1)

HOW TO SET MCC/MNC FOR ROAMING

1- Click on the roaming button.

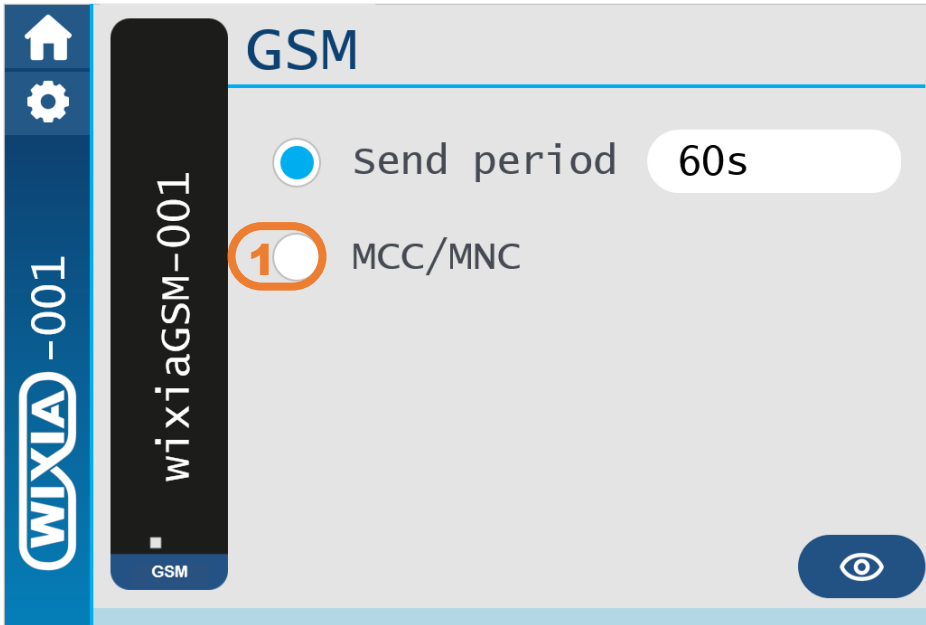

2- Enter the desired value with the keyboard.

3- Click on the validation button

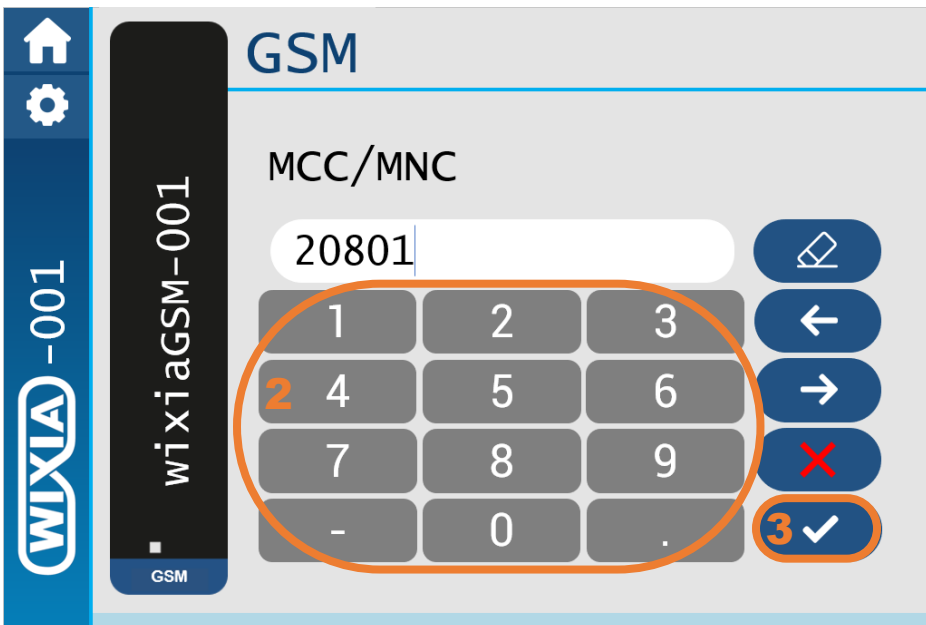

To change the previously configured MCC/MNC value, simply click on the white input box that indicates the time.

To deactivate roaming, click again on the button (1)

HOW TO MOUNT

1- Simply clip the module onto the DIN-35 rail.

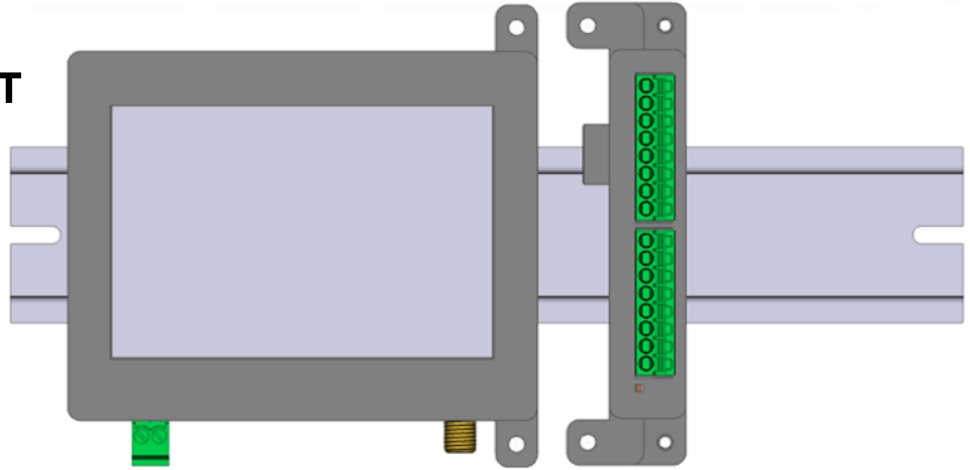

2- Slide the module to the left to connect it to the Wixia-Controller or to another module.

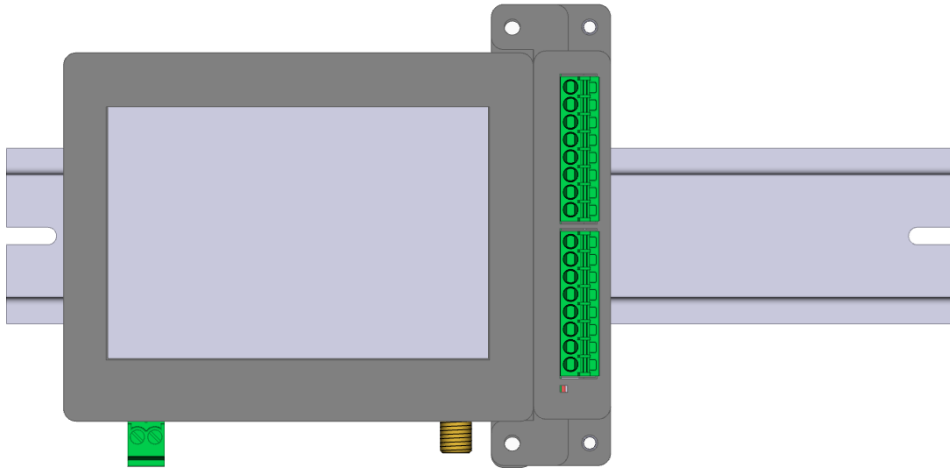

3- Fix the modules together using two M3x16 screws.

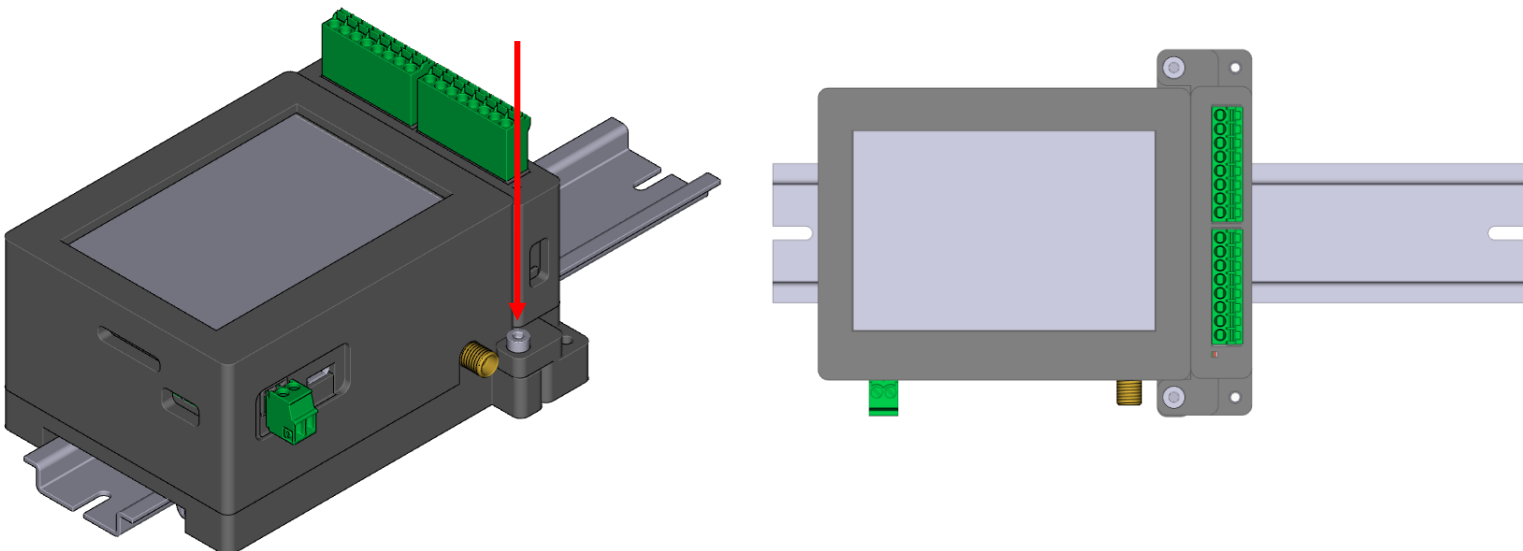

HOW TO UNMOUNT

1- Remove the fixing screws that hold the module together with the other modules

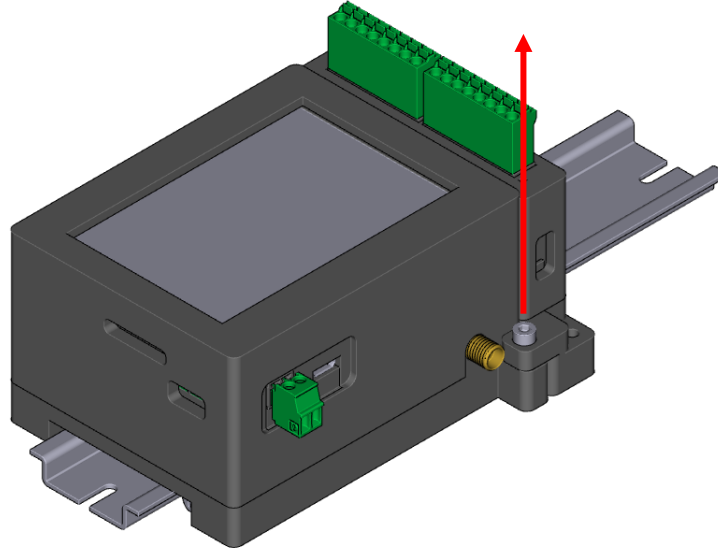

2- Slide the module to the right so that it is no longer connected to the Wixia-Controller or to another module.

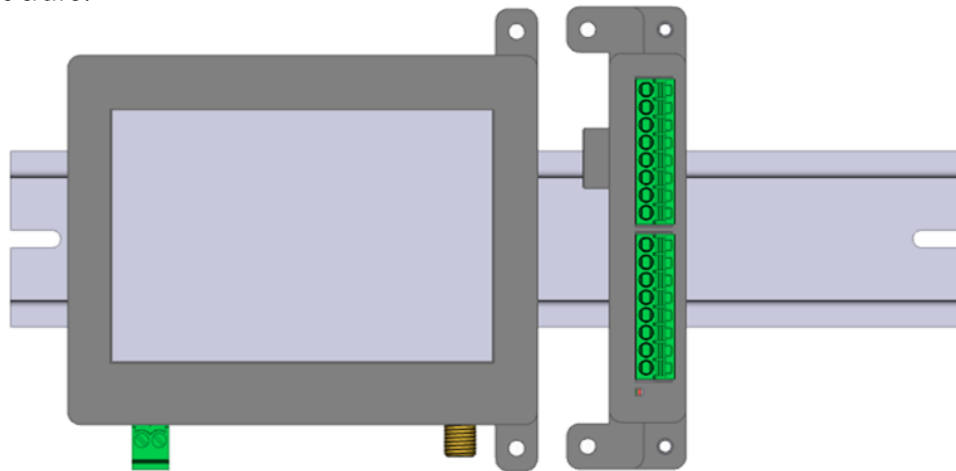

3- Slide the module to the right and push the module on the bottom while rotating the opposite angle to unmount it from the DIN-35 rail.

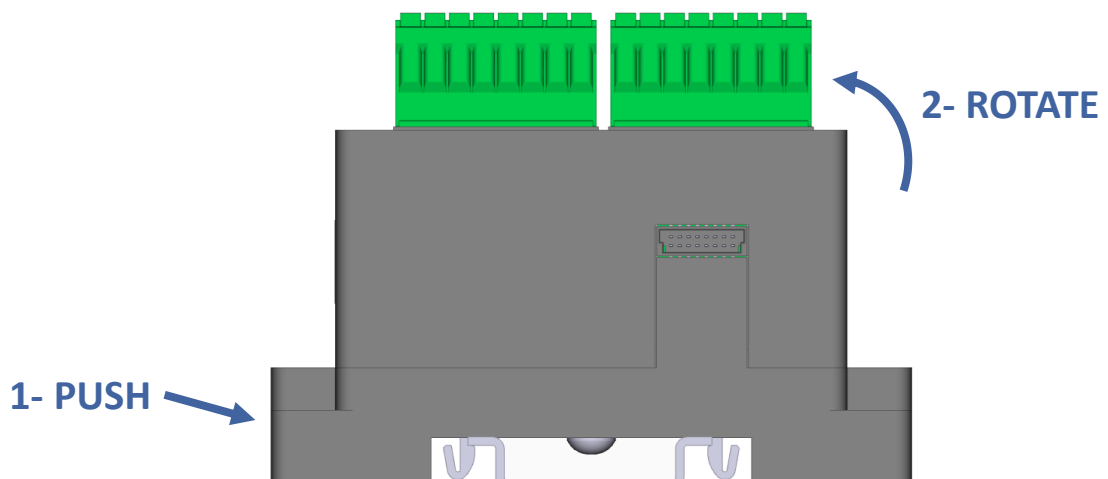

HAZARDS AND WARNINGS

Manufacturer is not responsible for user's failure to comply with the instructions contained in this manual.

Any service performed on this product must be completed by a qualified individual. Replacement of this product must be performed by a qualified individual.

Failure to use this equipment in accordance with the specifications in this documentation could lead to a hazard.

No parts in this device should be replaced or removed.

Disconnect all power supplies before servicing the equipment.

CONTACT



939 Rue de la Croix Verte,
Miniparc 12,
34 000 Montpellier
France

contact@applexia.fr
+33 (0)4 11 93 26 67